

QUICK GUIDE

EasyView

Fixed Mini IR Dome/Bullet Camera

ANVIZ®

Warning

- To reduce a risk of fire or electric shock, do not expose this product to rain or moisture.
- To avoid electrical shock, do not open the cabinet. Refer servicing to qualified personnel only.

Notice

- Please check if all the items on the package list have been included in package.
- This equipment must be installed and used in strict accordance with the instructions given in the user documentation. This equipment contains no user-serviceable components. Unauthorized equipment changes or modifications will invalidate all applicable regulatory certifications and approvals.
- Video and audio surveillance can be prohibited by laws that vary from country to country. Check the laws in your local region before using this product for surveillance purposes.
- When transporting the Anviz product, please use the original packaging or equivalent to prevent damage to the product.

Packing List

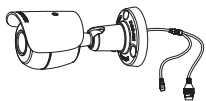

① Camera
x1



② Waterproof jacket
x1



③ Screws
x3



④ Mounting Templates
x1



⑤ Inner hexagon spanner
x1



⑥ Quick Guide
x1



⑦ Software CD
x1

Product Interface

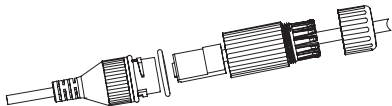

RJ45 Connector



Power Connector

Installation

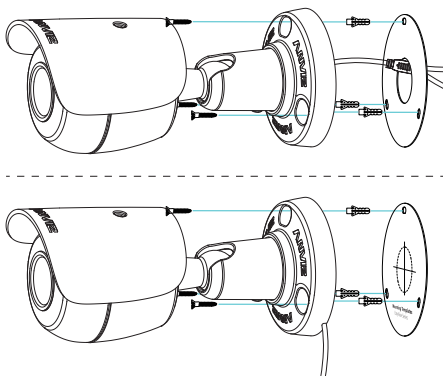

1. Plaster the sticker on wall or ceiling. Drill holes in the wall or ceiling according to the drawing.
2. Install the bracket:Loose the screw on bracket and fix the screws on the wall or ceiling to install the bracket.
3. Fixed the camera.(a)Adjust the direction of camera (b)Tighten the screw on bracket;(c)Connect the wiring(Network cable or power cable) to the camera.

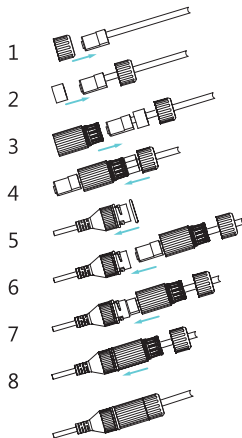

Simple Plug

Waterproof jacket (Type A) assembly instructions:

1. Insert screw top into riveted plug.
2. Insert silicone barrel-type circle into plug.
3. Insert waterproof jacket into plug.
4. Put silicone barrel-type circle into waterproof jacket.
5. Put seal ring onto RJ45 jack.
6. Slip plug into RJ45 jack.
7. Fasten waterproof jacket.
8. Tighten screw top.

Quick Operation/Configuration

DeviceDiscover software can automatically search the IP address of network cameras in the same local area network.

1. Click "Search" button.

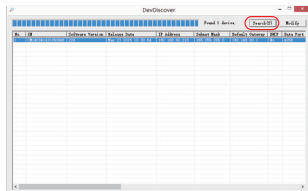

3. Input new IP address, subnet mask and gateway, then click "Apply" button to keep the modification.

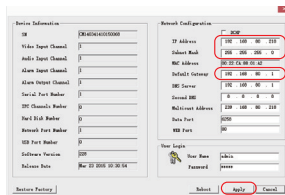

2. Choose the camera, and click "Modify" button.

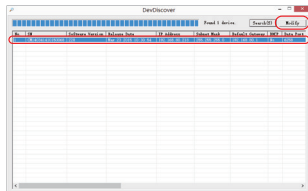

View Via Web Browser

Default configuration of IPC:

IP address: 192.168.100.100

User name: admin

Password: admin

Take Windows7 and IE10 for example.

1. Input the IP address of the camera in address bar and press [Enter].

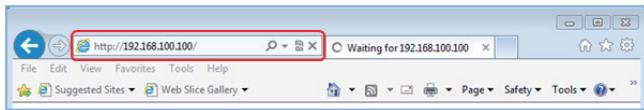

2. Input the "Username" (admin) and "Password"(admin) in the dialog box, and click "OK".

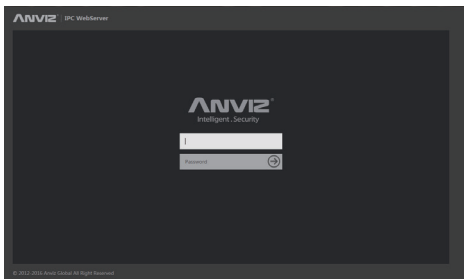

View Via Web Browser

3. View the image.



Note:

- Need to install the ActiveX control after step 1.
- Add IP address into trusted sites list and set the security level to [Medium] in IE browser [Tools/Internet Options/Security/Custom Level/Reset to...]
- System requirement: Microsoft Windows Operating System and Internet Explorer (Version 7.0 or later). IE8 is recommended.

Further information:

The user's manual and hardware instruction are available from the Anviz website at www.anviz.com or from the Anviz Network Video Product CD supplied with this product.



For more information, visit www.anviz.com, or email us support@anziv.com.

ANVIZ® brands and products are trademarked and protected under law in the United States. Unauthorized use is prohibited.
2017 © Anviz Global. All Rights Reserved.