

UltraMatch

Standalone Iris Recognition System

Quick Guide v1.0



Package List



Iris Terminal



x6



x2



Connect Cable



Network Cable

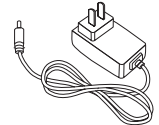

Power Cable

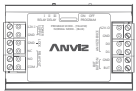

SC011



Quick Guide



CD



1*Master Card, 2*EM Card

Master Card: To enable Webserver and AP function.
EM Card: For comparison.

Note:

1. Please check if the package contains all the items listed. Contact the distributor if there is any problem.
2. Please keep the product away from the magnetic field, and avoid causing any damage to the device.
3. Please use the original power supply or refer to the instruction to get the right power supply.
4. Please strictly follow the instructions to install the product. Any damage to it caused by incorrect operation and wiring are not under warranty.

1

Installation

Step1: Fix back plate, connect power cable and ethernet cable.

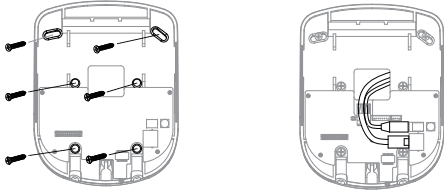

Step2: Check the connection between front plate and back plate.

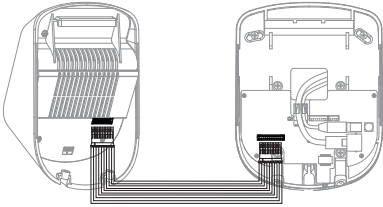

Step3: Fix screws at the bottom of device.

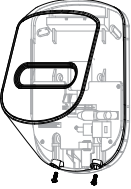

* Recommended mounting height

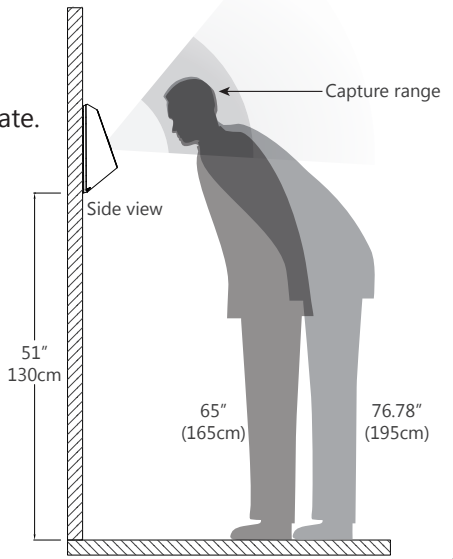

2

Operation

IMPORTANT:

Swipe master card to enable Webserver and AP function.
*The functions will turn off if no operation is done in 5 minutes.

1. Web Login

1) Connect to webserver: Type the default IP in the browser's address bar.



• Use AP function. Search and connect "UltraMatch*****" (The last 6 digits of SN) by using WiFi.
Default IP: 192.168.2.234.



• Connect your PC or laptop to iris terminal with ethernet cable.
Default IP: 192.168.1.218.
Note: Make sure the IP of PCs or laptops in the same segment with iris terminal.

2) Enter default administrator account (admin) and default password (12345), click [Login] to enter web management main interface.

Main Page:

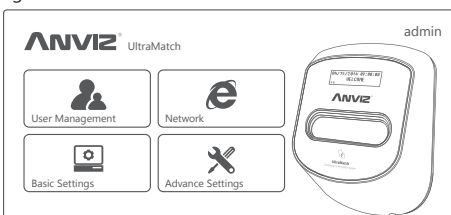

2. Add/Delete User

1) Users Management ->Add User ->Input user information

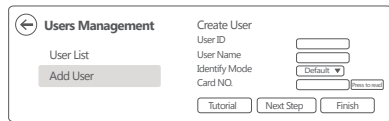

Note: There are 5 identification modes (Default; Card; Iris; Card and Iris; Card or Iris), you can choose. *Default mode can be defined in "Basic setting" part.
Click "Tutorial" -> "Register" -> Place your eyes in front of device to catch iris images -> Choose 2 clear images -> Click "Finish" -> Successfully add user.

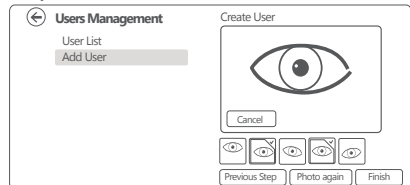

* How to place your iris to register: Look at the mirror in device, move forward or backward till the indicator light around mirror turns green.

2) User List ->Click"Delete" / Select the user you want to delete and then click"Delete Selected".

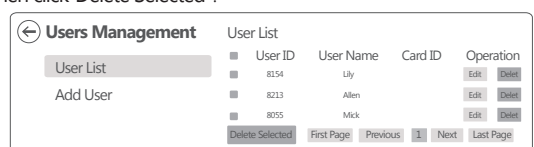

3

Operation

3. Add/Delete Administrators

Advance Settings ->Administrator Page:

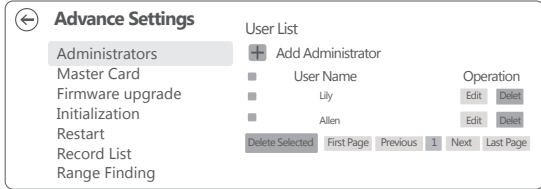

1) Add Administrator:
Click "Add Administrator" -> Input "Name" and "Password"
->Click "Submit".

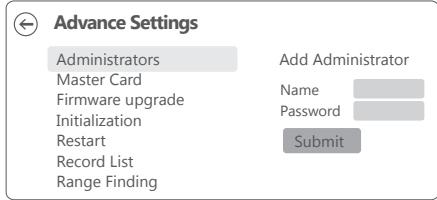

* The device supports up to 3 Administrators.

2) Delete Administrators:
Advance Settings ->Administrators ->Click "Delete" on right side / Choose the administrators and then click "Delete selected" ->Successfully delete administrator.

4. Add/Delete Master Card

* Master Card is for enable/disable Webserver and AP function.

Advance Settings ->Master Card Page:

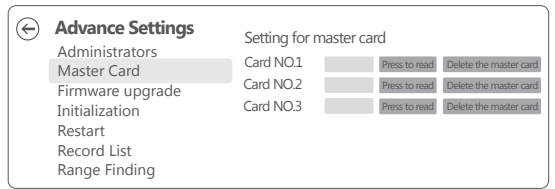

1) Add Master Card: Place Card over card reading area -> Click "Press to read"-> Successfully add card.

2) Delete Master Card: Click "Delete the Master card" -> Successfully delete card.

Connect to SC011

Wiegand Port:

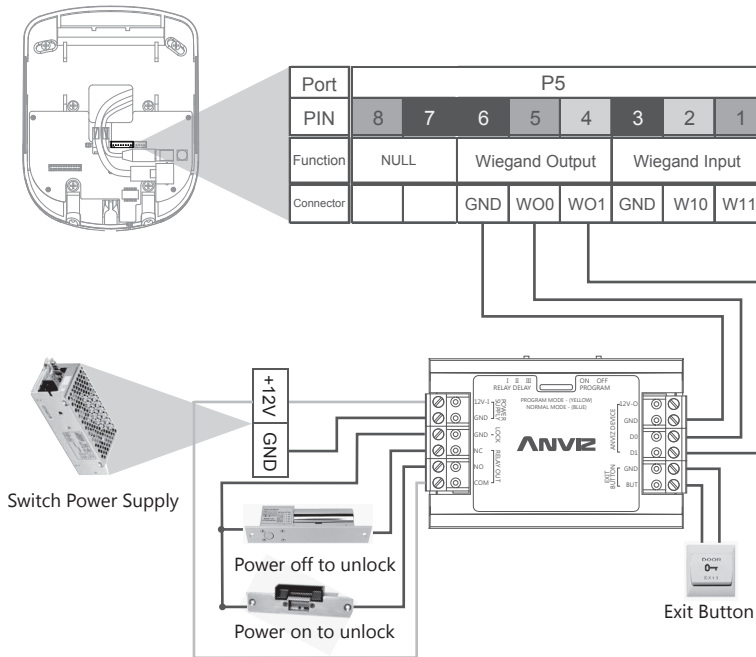

One Year Limited Warranty

Anviz Global Inc., (the "company") warrants to the original purchaser that the Company's products for one (1) year from the date of purchase to be free of structural and mechanical defects due to faulty materials or workmanship under normal use and service. During the warranty period, the company agrees to repair or replace, at its sole option, without charge to original purchaser, any defective component part of the hardware. To obtain service, original purchaser must return the hardware to the company in original product packaging or in an adequate container for shipping. The postage, shipping, and insurance charges incurred in shipping to the company will be paid by original purchaser, and all risk for the hardware shall remain with the original purchaser until such time as company takes receipt of the hardware. Upon receipt, the company will promptly repair or replace the defective unit, and then return said unit to original purchaser, postage and shipping prepaid. The company may use reconditioned or like-new parts or units, at its sole option, when repairing any hardware. Repaired products shall carry the same amount of outstanding warranty as from original purchase, or ninety (90) days, whichever is greater. Any claim under the warranty must include dated proof of purchase or invoice. In any event, the Company's liability for defective hardware is limited to repairing or replacing the hardware.

Items not covered by this warranty:

- (1) Shipping and freight expenses required to return the Company.
- (2) Failures, defects, or damage (including, but not limited to, any security failure or loss of data) caused by any third party product, service, or system connected or used in conjunction with the Product.
- (3) Any other incidental, indirect, special or punitive damages, whether based on contract warranty, tort (including, but on limited to, strict liability or negligence) patent infringement, or otherwise, even if advised of the possibility of such damages.
- (4) The Product use for purposes for which they are not designed or intended.
- (5) The Product which have been subjected to alteration, abuse, misuse, negligence or accident.
- (6) The product has been improperly stored, installed, maintained or operated.
- (7) The product has been used in violation of written instructions provided by the Company.
- (8) The product has been subjected to improper temperature, humidity or other environmental conditions or which, based on the Company's examination, do not disclose to the Company's satisfaction non-conformance to the warranty.

Additionally, this warranty DOES NOT COVER scratches abrasions or deterioration due to the use of paints, solvents or other chemicals. This warranty gives you specific legal right, and you may also have other right as otherwise permitted by law. If this Product is considered a consumer product, Please be advised that some laws do not allow limitations on incidental or consequential damages or how long an implied warranty lasts. So that the above limitations may not full apply. Refer to your local laws for your specific right under this warranty.

