

OA1000 Pro Series

Multimedia Fingerprint Terminal

Quick Guide v1.0

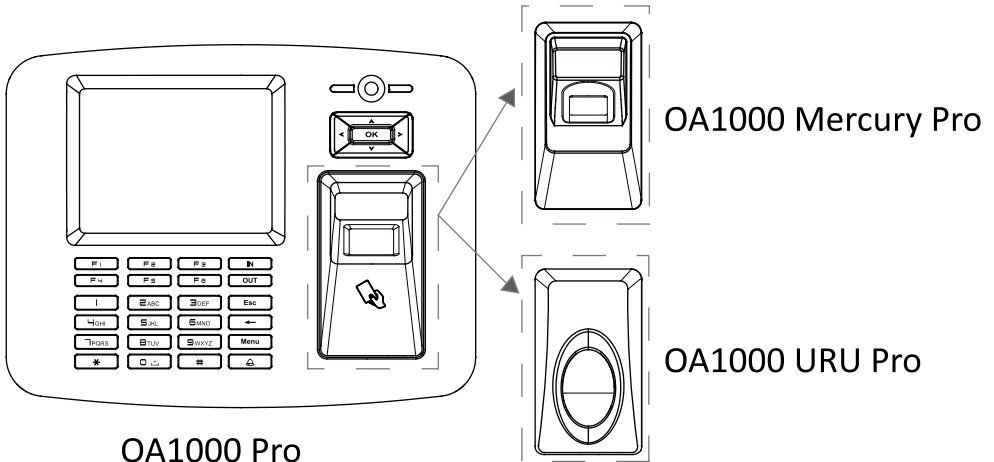

Features

- * Standard 3.5-inch Industrial TFT LCD
- * Dual-core 1GHz processor, Linux operating system
- * Optical fingerprint scanner, wear-resistant, long life
- * Multi-identification: Fingerprint, Card, ID + fingerprint, ID + Password, Card + fingerprint and Card + Password
- * Support Low-frequency card : EM Card and other compatible card(125kHz)
- * High-frequency card: Mifare, HID iClass, such as compliance with ISO14443 protocol card
- * Customers can customize a variety of voice and attendance status, support employee photo, message and multimedia video
- * Standard 1.3 million pixel camera, realtime snapshot to prevent the alternative attendance
- * Support TCP/IP, RS232, RS485, USB Host. Optional Wifi, 3G
- * Can be connected with the SC011 access controller system to achieve split security
- * Support real-time record downloading, online monitoring, remote server access control or high-end features such as Time Attendance
- * Registration capacity: 10000 Fingerprints and 200000 Records

Connect OA1000Pro to your Network

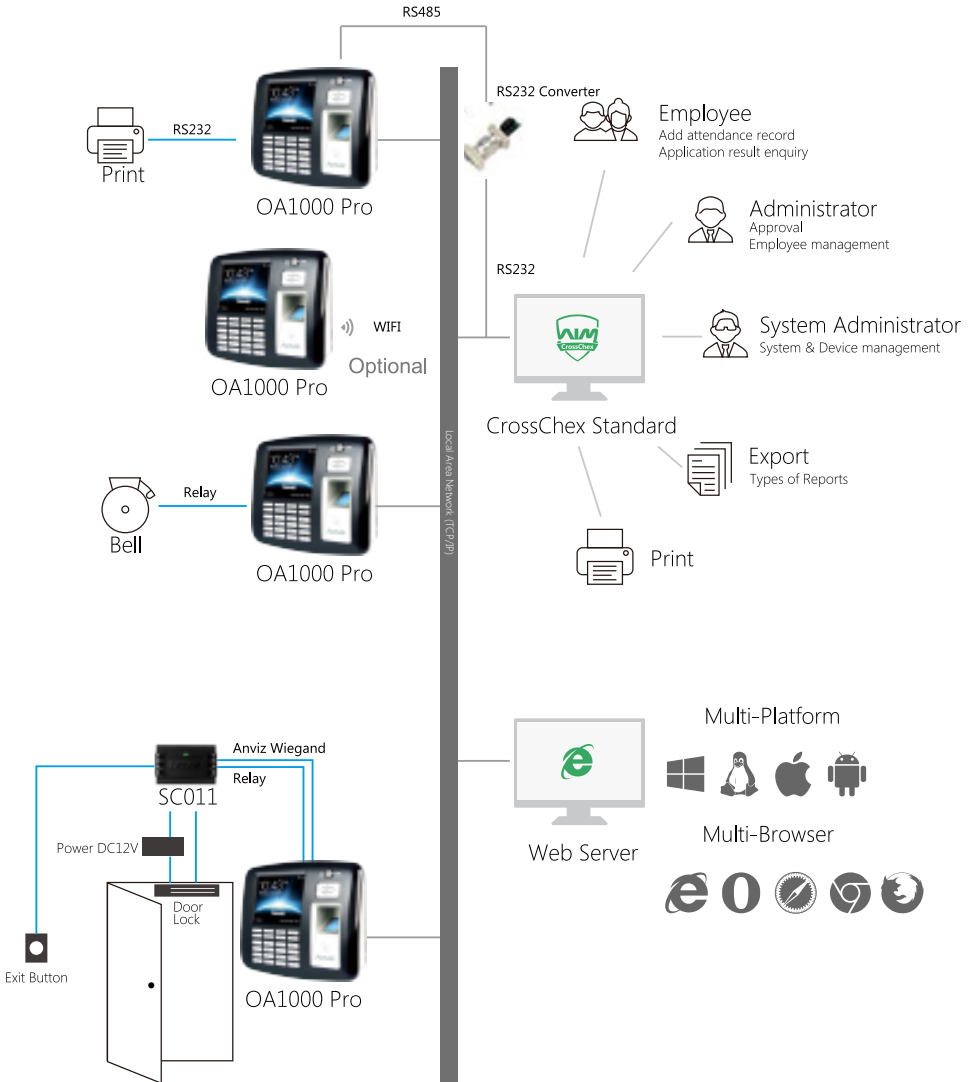

Have a question? Please feel free to send emails to support@anziv.com to get support.

Getting to Know the OA1000Pro

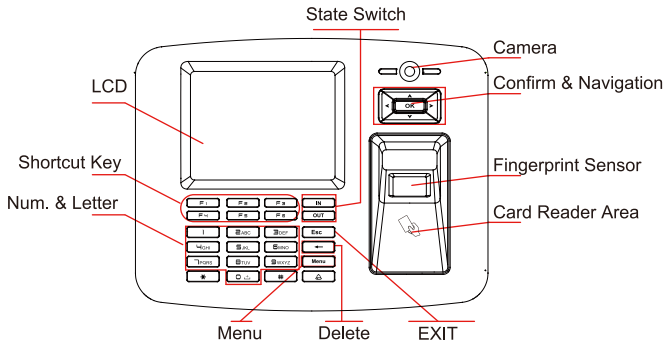

Wiring Instruction

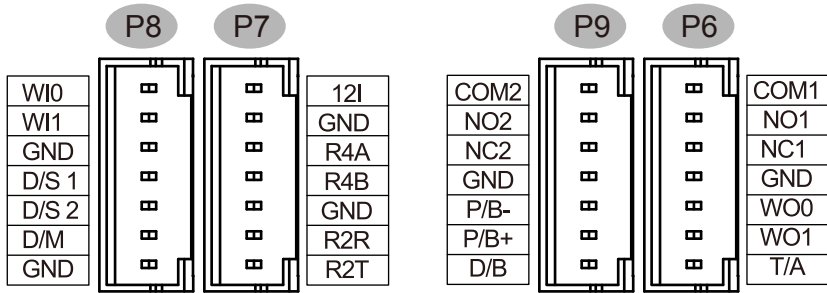

P8

PIN	Function	Description
WI0	Wiegand Input	Wiegand D0 Input
WI1		Wiegand D1 Input
GND	GND	GND
D/S 1	Exit Button	Trigger Relay2
D/S 2		Trigger Relay1
D/M	Door open Sensor	Trigger input
GND	GND	GND

P7

PIN	Function	Description
12I	Power (Red/Black)	DC12V
GND		GND
R4A	Data communication	RS485(A+)
R4B		RS485(B-)
GND		GND
R2R		RS232R
R2T		RS232T

P9

PIN	Function	Description	
COM2	Relay2	COM2	
NO2		NO2	
NC2		NC2	
GND	Door Bell	GND	
P/B-		With Power	BELL-
P/B+		With Power	BELL+(5V)
D/B		Without Power	Trigger Output

P6

PIN	Function	Description	
COM1	Relay1	COM1	
NO1		NO1	
NC1		NC1	
GND	Wiegand Output	GND	
WO0		Wiegand D0 Output	
WO1		Wiegand D1 Output	
T/A	Tamper Alarm	Without Power	Trigger Output

Important notice: Please follow the wiring diagram as it is displayed. Damaged products diagram as it is displayed. Damaged products due to improper wiring are not covered under the product warranty.

1. Switch Power Supply

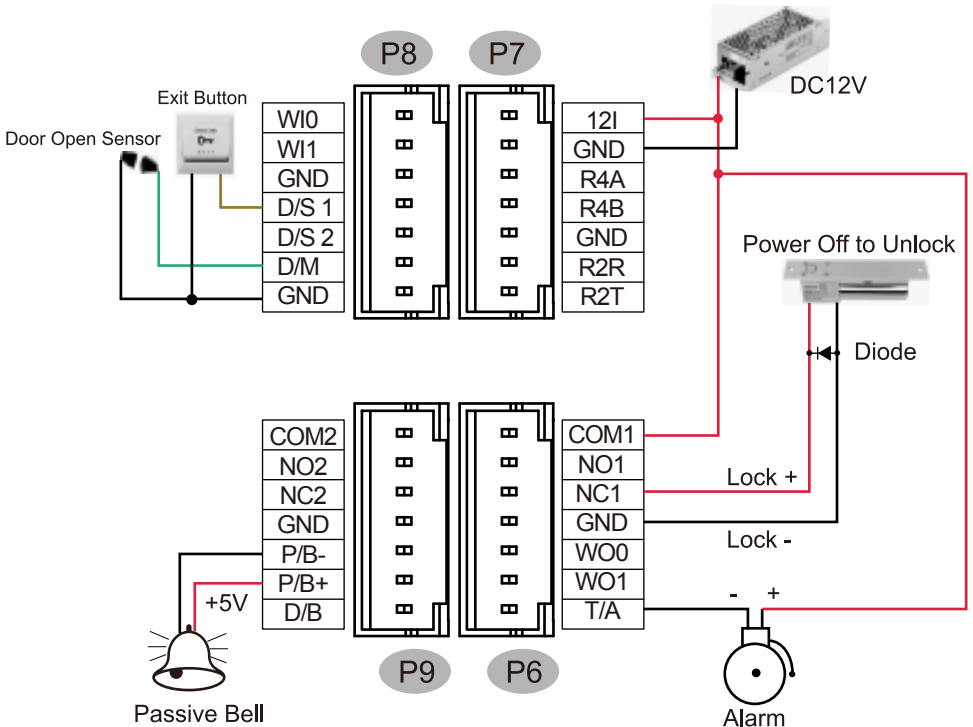

2. Access Control Power Supply

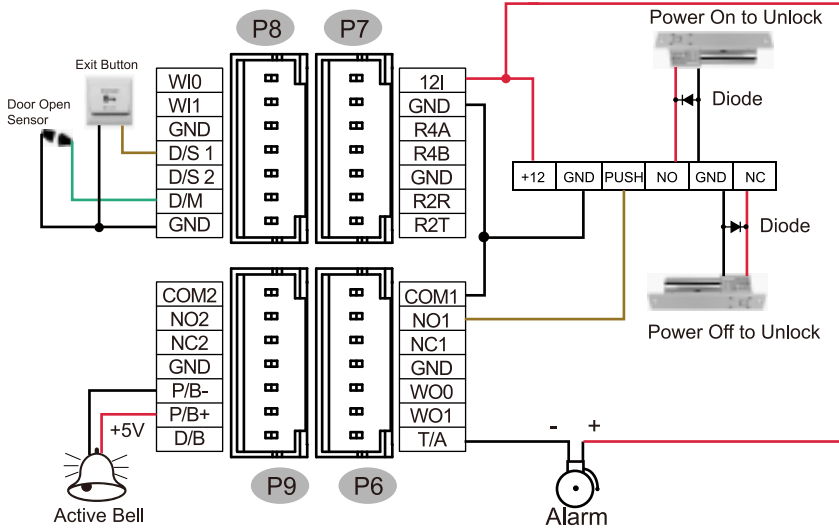

Installation Guide

1. Included In This Box

- 1 Terminal
- 2 Instruction Package
- 3 Accessory Package
- 4 Connector Jack

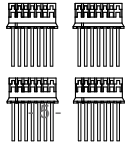

2. Mount the OA1000Pro to Wall

* Drill holes in the wall follow the hole position on back panel

* Install the mounting panel on the wall and plug in the charger and cables

* Slide the OA1000Pro down onto the panel and secure with the screw on the bottom

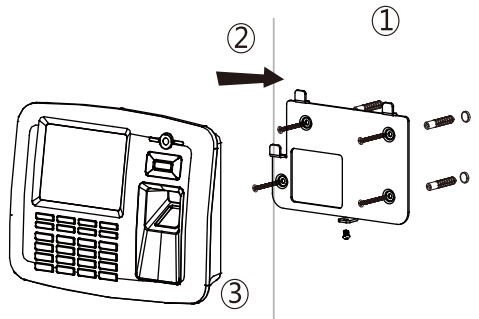

Basic Operation

1. Turn on the OA1000 Pro



Plug in the power supply and wait for the OA1000Pro boot up.

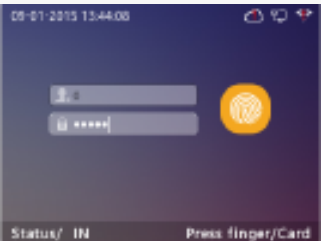

Press [Menu] key to go to Admin menu. Input "0" as ID and "12345" as password to log in.

* 0/12345 is the default Admin ID and password. You can change to your own the password or set other user as Admin later.

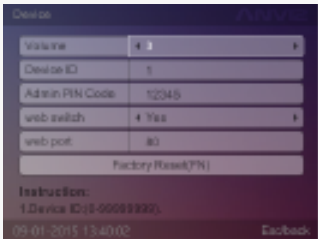

Browser the Setting \ Device menu to view or edit the Device ID and Admin PIN Code.

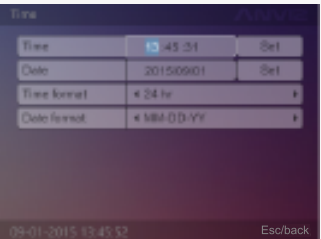

Go to Setting \ Time menu to set up date and time.

2. Add Users to OA1000Pro

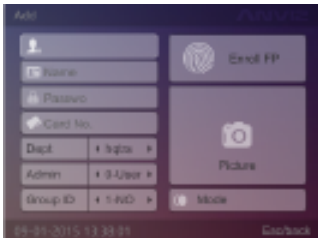

Go to User \ Add menu. Follow the menu to input ID, name, password and swipe card. Move the cursor to "Enroll FP" and "Picture" section and click [OK] key.

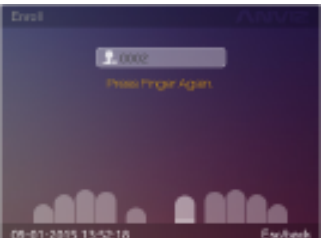

Scan the same finger twice to enroll the fingerprint.

Special function using steps: Enrolled picture can display after user identification passed terminal but only if you go to Setting \ Display menu choose 'Storage Picture' as 'Pic'. Camera will take a picture after user identification passed terminal but only if you go to Setting \ Display menu choose 'Storage Picture' as 'Snapshot'.

3. Input Characters

When you edit name or WiFi password, you may need to input characters. Here are the steps to input characters:

- * Using the up and down arrow key to move the cursor to the field.
- * Press [#] key on the keypad, a character input window "Aa" will be displayed on the bottom of the screen. Then press the number/letter key. A second window will appear and you can select the letter by number key .
- * Press [F2] key on the keypad, the character input window will toggled between "Aa", "123", ",.!?" and "拼". You can select the window to input the letter, number or special symbols.

4. Verity the Fingerprint

■ Correct method :

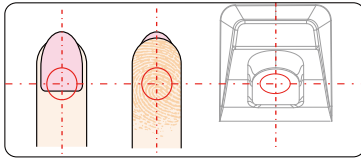

Place finger in the center of the sensor.

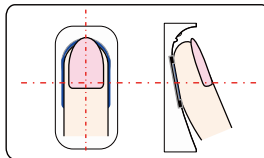

Place finger flatly and smoothly on the sensor.

■ Incorrect method :

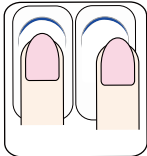

Finger not placed on the center of the sensor



Finger placed inclined

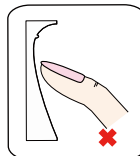

Use of fingertip

Note:

1. It is better for each user to register two finger prints in case of one finger can't work.
2. Place finger flat and make sure the center of the finger is on the center of scanner window and press a little hard on scanner, so it can scan as large finger area as possible to extract enough minutia.
3. Keep the angle and direction of finger the same each time placing on scanner.
4. If your finger has sweat or water, please dry it first and then register the finger.
5. If your finger is too dry, make it a little wet or touch the forehead to increase the wetness of the finger, press a little hard on scanner. (The dry finger can cause the finger image not coming out clear enough.)
6. Avoid the callus, peeling, or injury of the finger to ensure the register and identification successful.
7. You can register the thumb first, and then index finger or middle finger to increase the precision.

5. Setup the OA1000Pro Communication

- * Go to Network \ Communication Mode to select Server, Client, RS232 or RS485 mode
- * Go to Network \ Internet menu to select Ethernet or WiFi
- * Go to Network menu to setup Ethernet or Wifi parameter according to your network settings
- * Ping the IP address of OA1000Pro from the management computer. Make sure the Ping is successful

5.1 Ethernet Settings

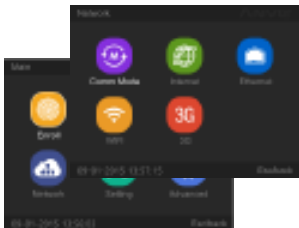

Go to Network menu.

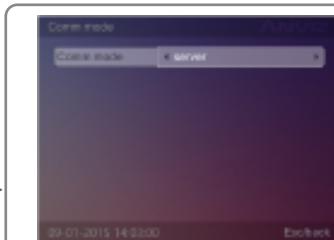

Go to Comm Mode menu to select Server, Client, RS232 or RS485 mode.

This mode is used to choose communication style with management software, you can choose RS232 or RS485 without setting network environment.

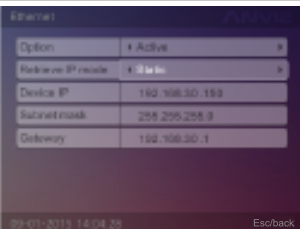

Go to Ethernet menu to change TCP/IP settings.

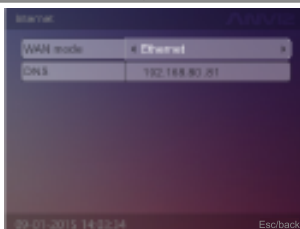

Go to Internet menu to set up WAN mode as 'Ethernet' and input the DNS server IP address.

5.2 WiFi Settings (*Optional)

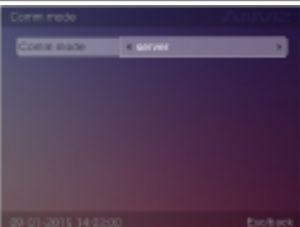

Go to Comm Mode menu to select Server, Client, RS232 or RS485 mode.

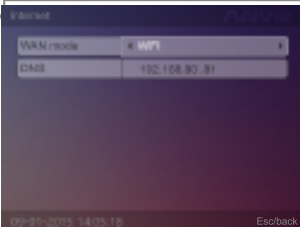

Go to Network/Internet menu to set up WAN mode as 'WiFi' and input the DNS server IP address.

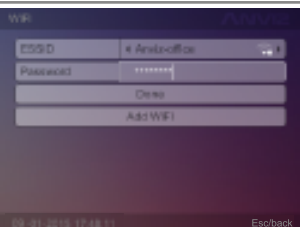

OA1000 Pro will search for WiFi network automatically. Select the WiFi network and input password.

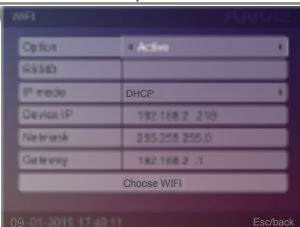

Go to WiFi menu to change TCP/IP settings. Then select 'Choose WiFi' to go to the second window.

Webserver Software

* Please enter the IP address of device from IE.

* Login Client-end software by user name and password(The default user name is admin and password is 12345). **Pay attention: the name of 'admin' can't change to any other name.**

Working with Management Software

1. Install the Management Software on Computer

Put the CD in the management computer. The installation program will run automatically.

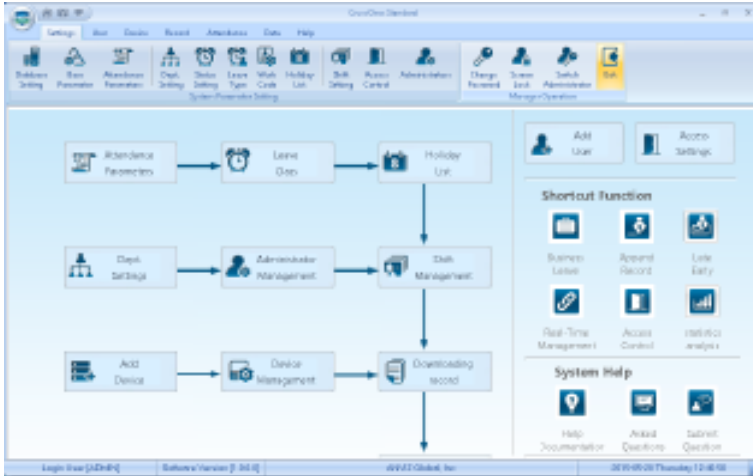

2. Enable Communication between OA1000Pro and the Management Software CrossChex

* Turn on management software CrossChex

* Go to Device tab. Search and Add the OA1000Pro to management software CrossChex

* Click Synchronize Time button to communicate with OA1000Pro. If Synchronize is successful, the device icon will turn to blue

3. The Management Software CrossChex Features

* Device \ Backup User: Download user info from OA1000Pro to CrossChex

* Device \ Download Records: Download records from OA1000Pro to CrossChex

* User \ Modify: Edit name or other user info. Then click "Upload User" to Upload user info to OA1000Pro device

* Record \ Search: Search and view the records

* Attendance: Calculate, Search results and Generate reports

* Data \ Backup Database: Backup Database

* Setting \ Shift: Set up Time Table and Scheduling

* Device \ Device Parameter: Set up device, Clear records on OA1000Pro or Reset OA1000Pro to factory settings

