

M7

PoE-Fingerprint and RFID Access Control

Quick Guide v1.1

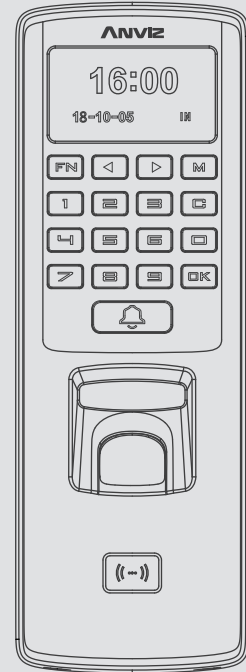

www.anviz.com

*The products are subject to change without notice

1. Package List

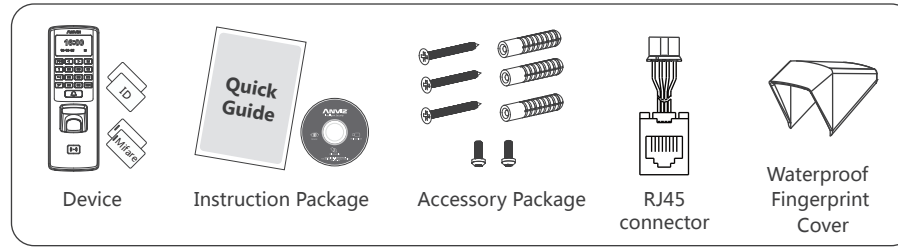

2. Installation Diagram & Installation Step

Diagram:

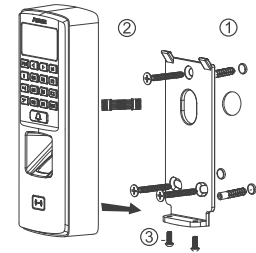

Installation Steps:

- ① Drill holes in the wall follow the hole position on back panel.
- ② Install and fix back panel on the wall, connect related cables.
- ③ Slide the M7 onto the panel and secure with the screw on the bottom of M7.

3. Wiring Instruction

NO	Cable Color	Description	J9
1	Grey		POE & TCP/IP
2	Grey		
3	Grey		
4	Grey		
5	Grey	RX-	
6	Grey	RX+	
7	Grey	TX-	
8	Grey	TX+	
9	Grey	D/M	

NO	Cable Color	Description
1	Red(Heavy Line)	12V
2	Black(Heavy Line)	GND
3	Black(Heavy Line)	GND
4	Yellow(Heavy Line)	NO
5	Purple(Heavy Line)	COM
6	Blue(Heavy Line)	NC

NO	Cable Color	Description
1	Orange	D/S
2	Blue	RS485B
3	Brown	RS485A
4	Black	GND
5	Red	Bell+
6	Grey	Bell-
7	Black	GND
8	White	WO1/WI1
9	Green	WO0/WI0

* Important notice:
Please follow the wiring diagram as it is displayed. Damaged products due to improper wiring are not covered by product warranty.

wiegand input/output settings: to connect M7 with CrossChex management software, and choose "device management" terminal parameters\Wiegand options (M7) to set up.

4. Power Over Ethernet Supply

Power Over Ethernet provide device network communication and the power is enough for both device and lock working. Total load should not exceed 12.95W when using POE supply to directly drive the electric lock to prevent damage to M7.

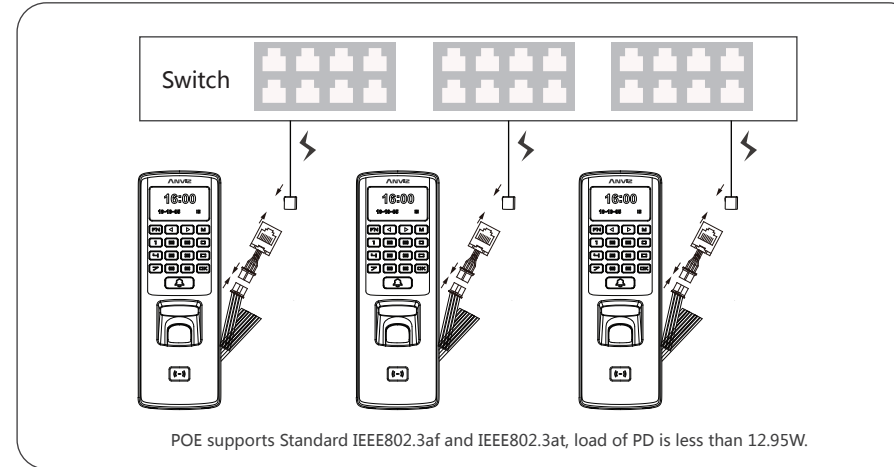

5. Access Control Reader & SC011

SC011 can work with M7 by Anviz encrypt wiegand code authorized to set up a distributed Access control system. You can buy SC011 from our sales.

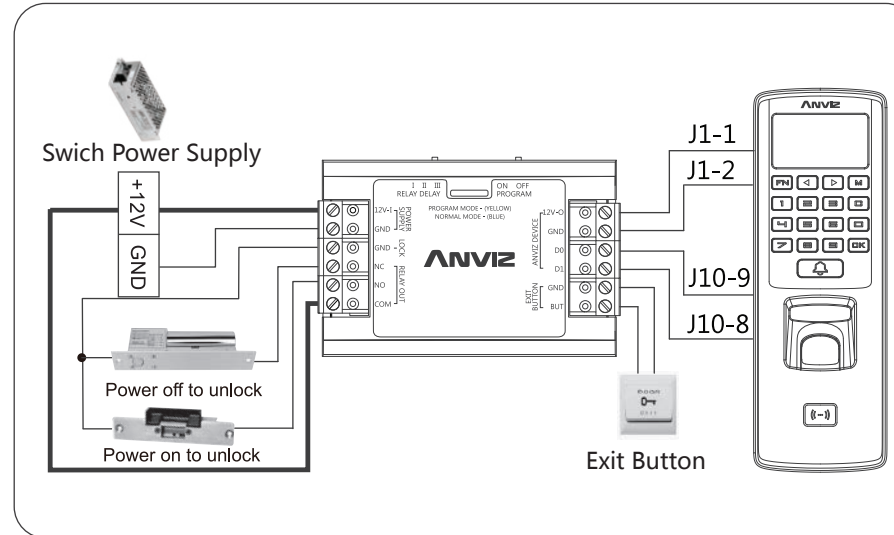

6. Access Control Reader & Access Control Power Supply

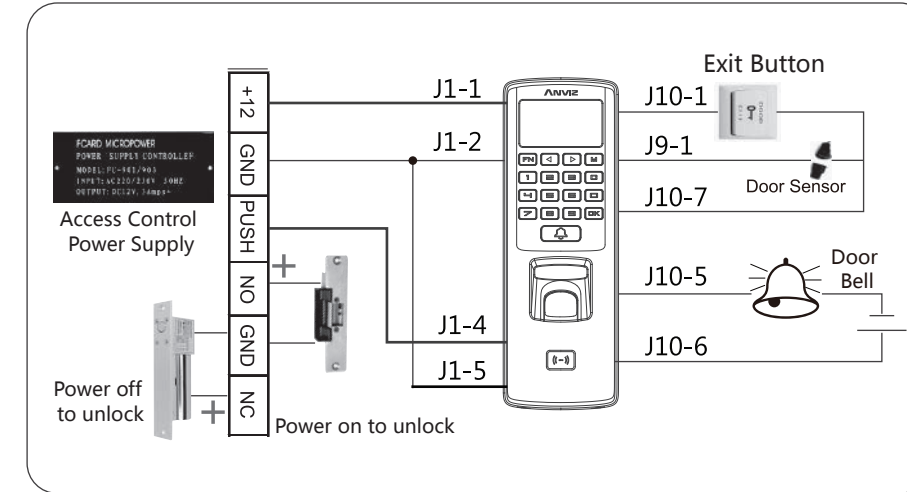

7. Access Control Reader & Switching Power Supply

The following wiring is recommended to prevent damage to the device when load is large.

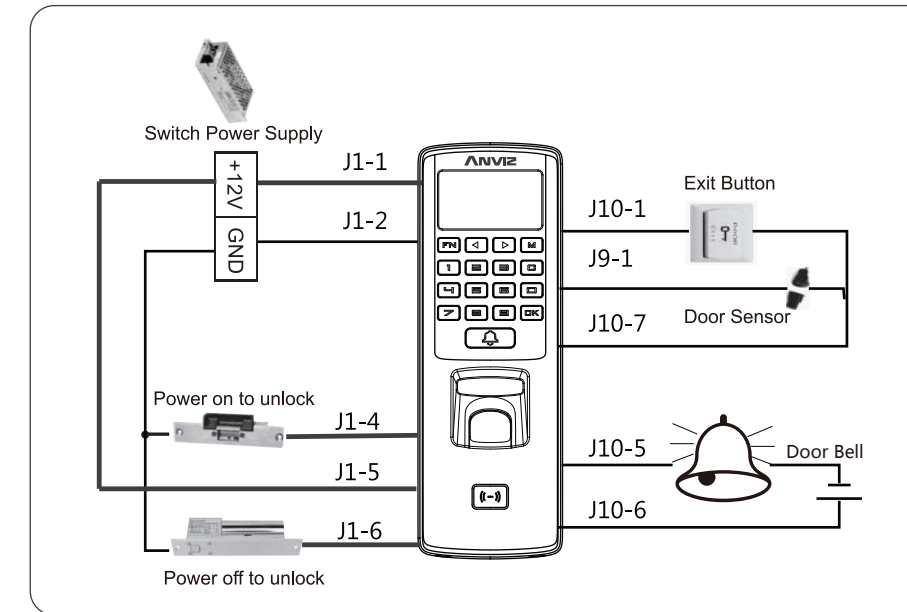

8. Getting to Know the M7

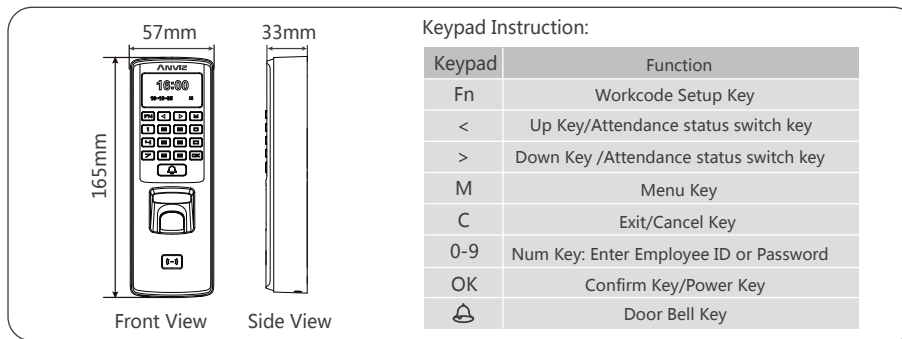

9. Menu List

Press [M] key to enter system management menu.(This requires the administrator authorization if there is admin registered in the system.)Menu List:

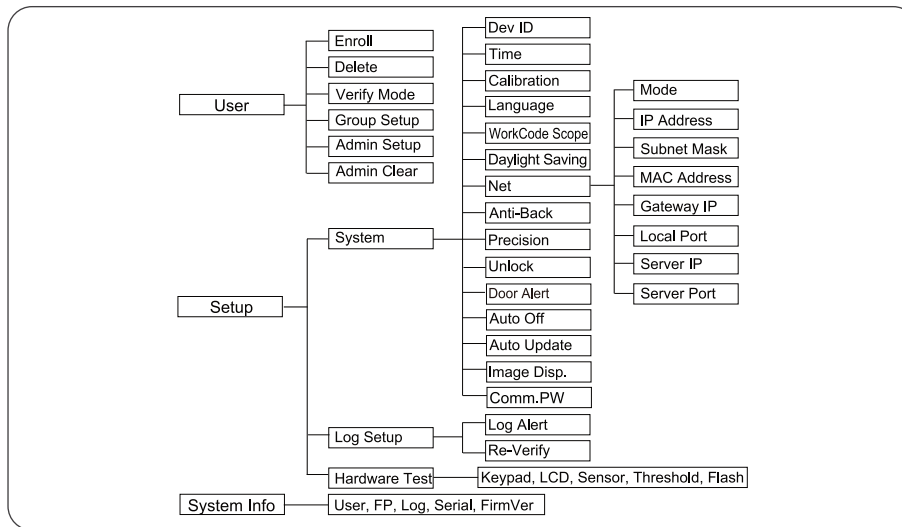

10. Operation Guide

① Enroll User:Each user can register two fingerprints, one password and one RFID card.



• Enroll Fingerprint:Place the same finger on the sensor twice in a row to enroll fingerprints.

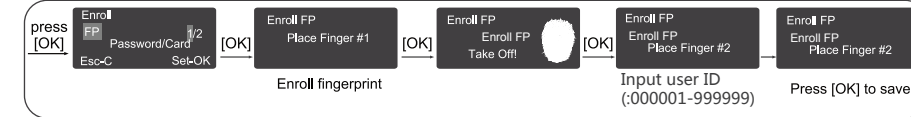

• Enroll Password:Password length:000000-999999.

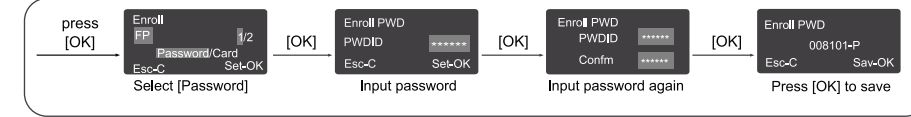

• Enroll Card:

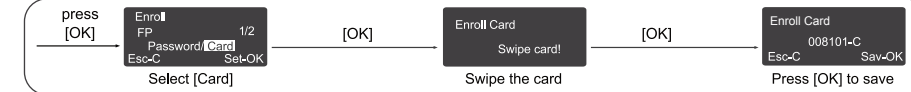

② Admin Setup:Admin(Administrator)has full access permissions to the device. It is recommended to assign a minimum of two administrators to each unit.

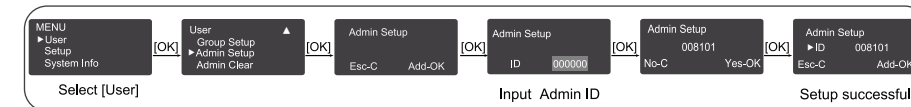

11. Other Setup

[M]→User→Verify Mode:

Item	Explanation
ANY	Fingerprint only, Card only or ID+Password only
ID+FP	Enter the user ID first then verify the fingerprint
RF+PW	It requires both Card and Password verification together
PW+FP	It requires both Password and Fingerprint verification together
RF+FP	It requires both Card and Fingerprint verification together
Factory default setting	ANY

[M]→Setup→System→WorkCode Scope:

Item	Explanation
0-999999	Valid scope for the Workcode
Factory default setting	Max 999999 Min 0

⚠ Tips: WorkCode indicates the work type, easily distinguishes which attendance record is related to which work type.

[M]→User→Group Setup:

Item	Explanation
G00	The user in Group00 can not open the door
G01	The user in Group01 can open the door anytime
G02-16	It is according to the Group & Time zone setting which can be set through the software
Factory default setting	G01

⚠ Tips: Group setup is used for managing the access control privileges. Each group can contain 4 time zones.

[M]→Setup→System→Dev ID:

Item	Explanation
NULL-99999999	Device ID of the unit which is required in software communication
Factory default setting	1

⚠ Tips: It doesn't allow duplicate Device ID in one LAN. Otherwise, it will cause software communication error. Then ID as "NULL" must adopt last 8 digit of the serial number for software communication.

[M]→Setup→System→Net:

Item	Explanation	Factory default setting
Mode	TCP/IP Server mode: Common network mode TCP/IP Client mode: Only communicate with the PC which has static IP	Client Mode
IP Address	Set terminal IP address when communication of TCP/IP. IP address must be a static IP address	192.168.0.0.218
Subnet Mask	Subnet Mask of the LAN	255.255.255.000
MAC Address	Unique Physical address of the network module. This setting can not be modified.	
Gateway IP	Default Gateway of the LAN	192.168.0.0.001
Server IP	The IP address of the Server Machine when using Client Mode TCP/IP communication.	192.168.0.0.007
Server Port	It's the Software Port number used when the reader configured for TCP/IP communication	5010

[M]→Setup→System→Unlock:

Item	Explanation
1-15	The duration of the audible alarm to notify employees of events, (Lunch, break, Off Duty)
No	It generates a door dose signal immediately after it generates the door open signal
Factory default setting	5

Door Alert:

Item	Explanation
1-99	It generates the door open alarm signal if the door open time is longer than the preset value
No	Disable the door open alarm
Factory default setting	No

12. Verify the Fingerprint

• Correct method:

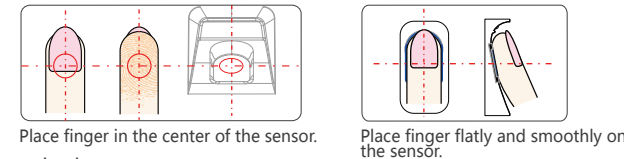

• Incorrect method:



* NOTE:

- It is better for each user to register two fingerprints in case of one finger can't work.
- Place Finger flat and make sure the center of the finger is on the center of scanner window and press a little hard on scanner, so it can scan as large finger area as possible to extract enough minutia.
- Keep the angle and direction of finger the same each time placing on scanner.
- If your finger has sweat or water, please dry it first and then register the finger.
- If your finger is too dry, make it a little wet or touch the forehead to increase the wetness of the finger, press a little hard on scanner. (The dry finger can cause the finger image not coming out clear enough.)
- Avoid the callus, peeling, or injury of the finger to ensure the register and identification successful.
- You can register the thumb first, and then index finger or middle finger to increase the precision.

13. Working with Management Software

① Install the Management Software on Computer

Put the CD in the management computer. The installation program will run automatically.

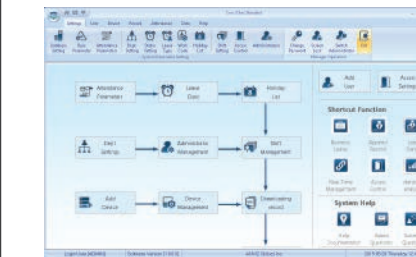

How to connect M7 with Software?
Connect M7 to Network

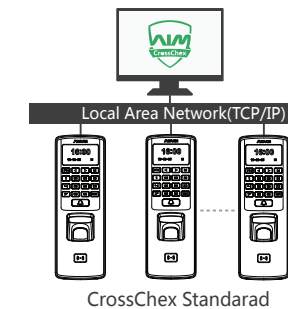

② Enable Communication between M7 and the Management Software CrossChex.

- Turn on management software CrossChex
- Go to Device tab. Search and Add the M7 to management software CrossChex
- Click Synchronize Time button to communicate with M7. If Synchronize is successful, the device icon will turn to blue.

③ The Management Software CrossChex Features.

- Device\Backup User:Download user info from M7 to CrossChex
- Device\Download Records:Download records from M7 to CrossChex
- User\Modify>Edit name or other user info. Then click 'Upload User' to Upload user info to M7 device.
- Record \Search:Search and view the records
- Attendance:Calculate, Search results and Generate reports
- Data\Backup Database;Backup Database
- Setting\Shift:Set up Time Table and Scheduling
- Device\Device Parameter:Set up device, Clear records on M7 or Reset M7 to factory settings.

Any questions? Please feel free to send emails support@anziv.com to get support.