

T5 Pro/T5

Professional Access Control Reader

Quick Guide v2.0

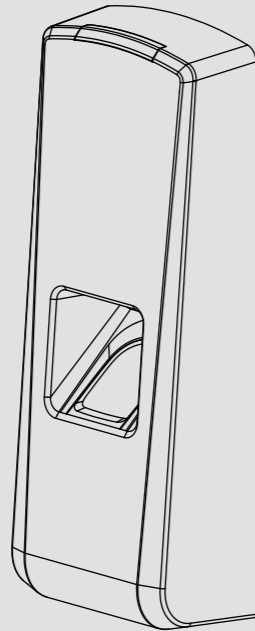

Anviz brand and product are trademarked and protected under law of the United States. Unauthorized use is prohibited.

For more information, please visit www.anviz.com, or send email to sales@anviz.com for more help. ©2018 Anviz Global Inc. All Rights Reserved.

1. Package list

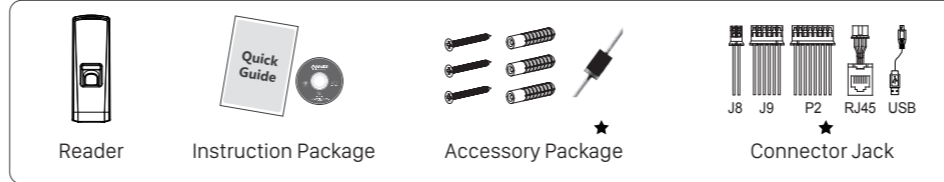

2. Installation Diagram

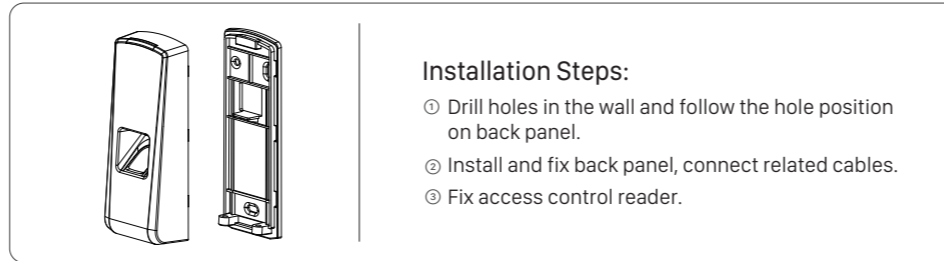

3. Wiring Instruction

The interface marked with ★ for specific models, Please according to the practical device to wire.

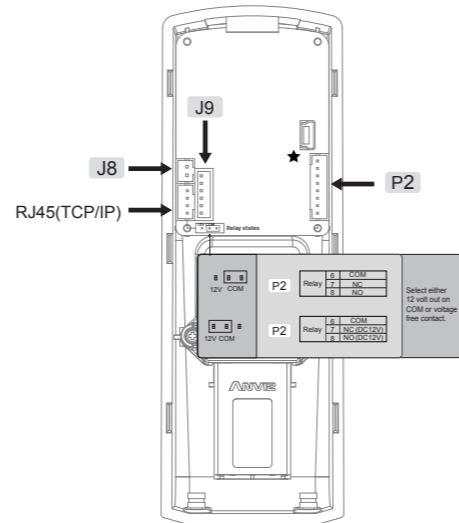

Function	PIN	Description
Power	1	DC12V
	2	GND

Function	PIN	Description
Wiegand Output	1	Wiegand DATA0 Output
	2	Wiegand DATA1 Output
	3	GND
RS485	4	RS485A
	5	RS485B
	6	GND

Function	PIN	Description
Door Sensor	1	Trigger Input
	2	Trigger Input
Relay	3	
	4	
	5	GND
	6	COM
	7	NC
	8	NO

Important Notice Please carefully follow this wiring diagram, If the reader gets damaged by incorrect wiring then your warranty will be void.

4. Access Control Reader & Power Supply

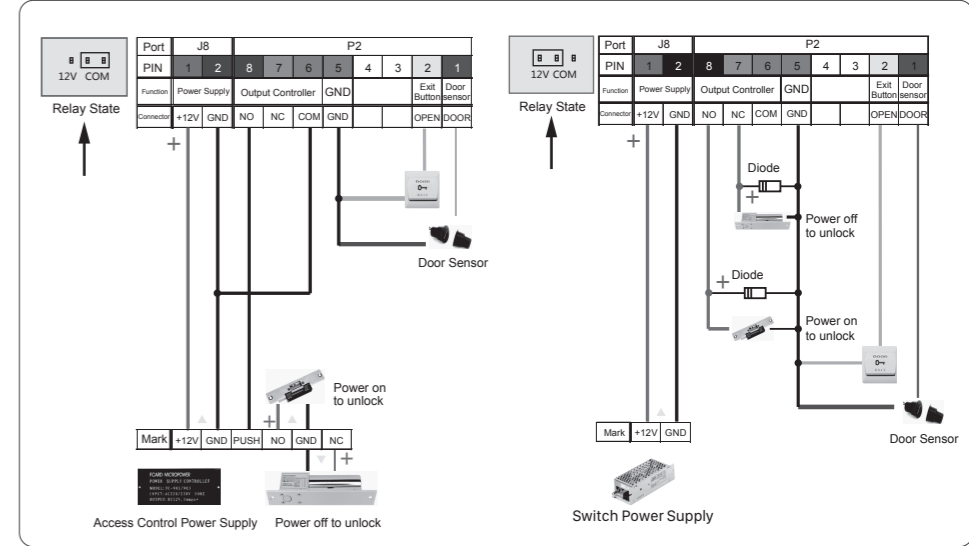

5. Access Control Reader & Controller 6. Communicate with PC

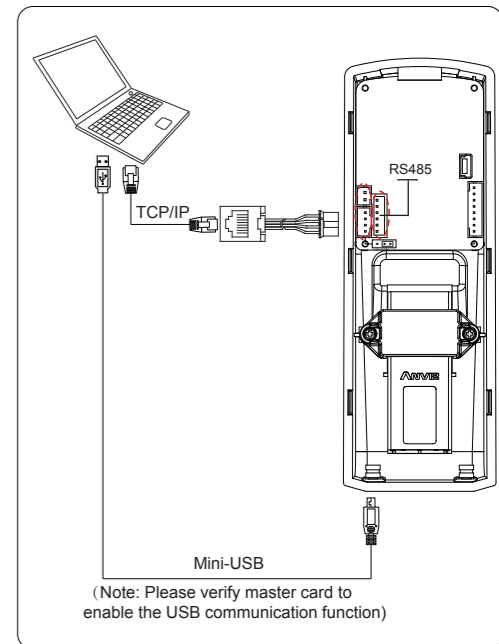
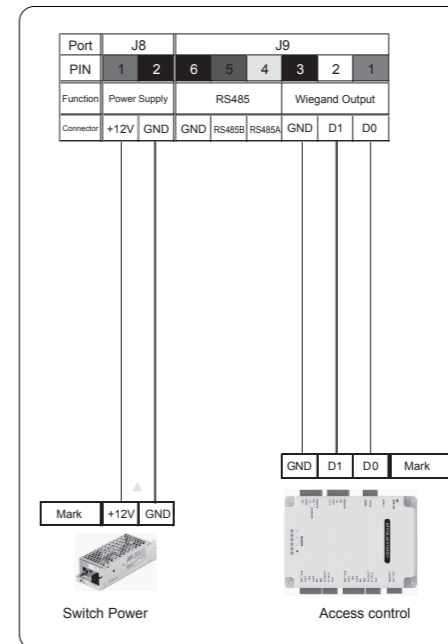

7. Reader Appearance

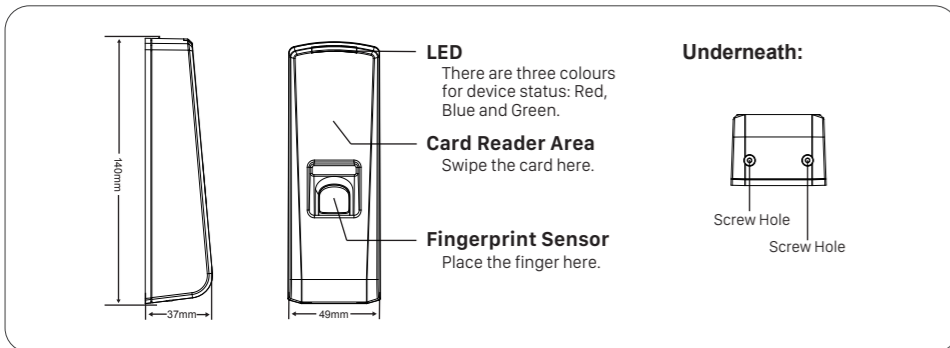

8. Illustration for placing finger

• Correct method:

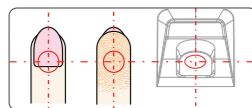

Place finger in the center of the sensor.

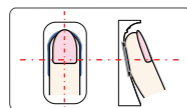

Place finger flatly and smoothly on the sensor.

• Incorrect method:

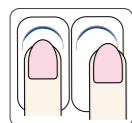

Finger not placed on the center of the sensor.



Finger placed inclined.

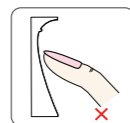

Use of fingertip.

9. Operation Guide

• Power On:

Power the device by DC 12V and blue LED flashes fast and Fingerprint Sensor lights with beeps.

There are 4 cards in the package: Enroll Card Delete Card User Card * 2

• User registration :

• Add Fingerprint Only: (Operation Steps show as figure 1.1)

After registering you can continue register another user or swipe Enroll Card save and exit.

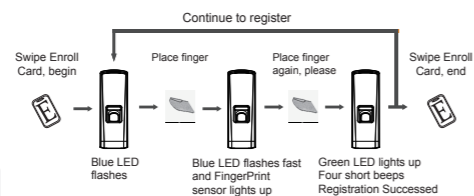

Figure 1.1

• Add Card Only: (Operation Steps show as figure 1.2)

After registered you can continue register another user or swipe Enroll Card save and exit.

▲ Notice:

When swipe card, Red LED flashes twice with two long beeps means the User Card have been registered.

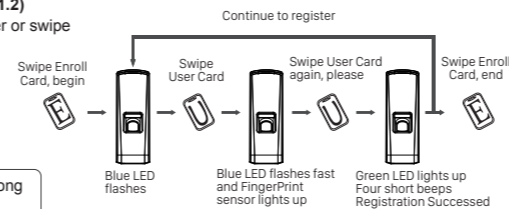

Figure 1.2

• Add Card+Fingerprint: (Operation Steps show as figure 1.3)

After registered you can continue register another user or swipe enroll card save and exit.

▲ Notice:

When swipe card, Red LED flashes twice with two long beeps means the User Card have been registered.

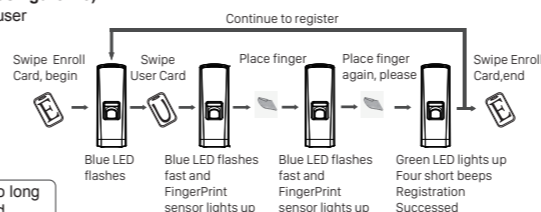

Figure 1.3

• Delete User:

• Delete fingerprint only: (Operation Steps show as figure 1.4)

After deleting you can continue delete another user or swipe Delete Card save and exit.

▲ Notice:

When place finger, Red LED flashes with long beep means the fingerprint does not exist in the device.

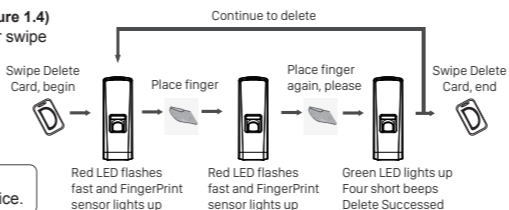

Figure 1.4

• Delete Card / Card+Fingerprint: (Operation Steps show as figure 1.5)

After deleting you can continue delete another user or swipe Delete Card save and exit.

▲ Notice:

When swipe card, Red LED flashes with long beep means the fingerprint does not exist in the device.

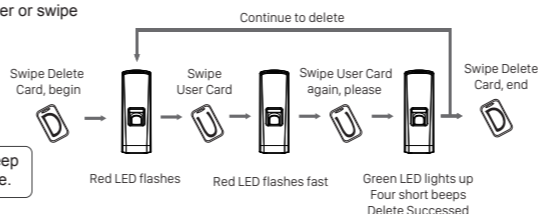

Figure 1.5

10. Function button

• Function Button

Press the button until heard beeps, that eliminate Enroll Card and Delete Card information in the device. After that MUST register management cards (Enroll Card and Delete Card) to run the machine.

▲ Notice:

The operation will not delete any user data stored in the device.

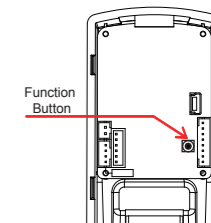

• Register Management Cards (Enroll Card and Delete Card)

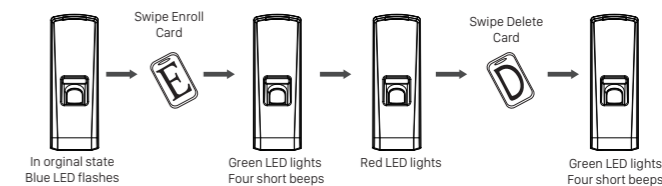

Figure 1.6