

C2/C2C

Color Screen Fingerprint & RFID Time Attendance

Quick Guide V2.0



C2

C2C

1. Product Appearance

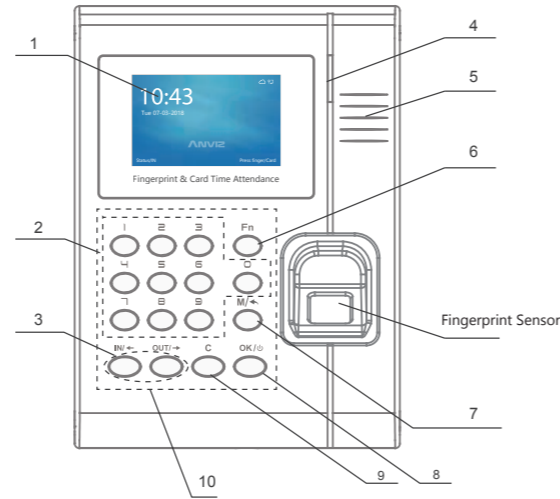

C2

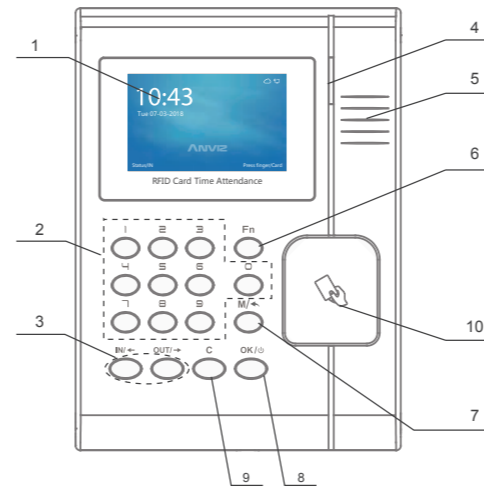

C2C

- 6. Function Key
- 7. Menu/Back Key
- 8. Confirm Key
- 9. Delete Key
- 10. Swipe Card Area

- 1. LCD
- 2. 0-9 Num.Key
- 3. Status Key/direction key
- 4. LED
- 5. Speaker

2. Package List

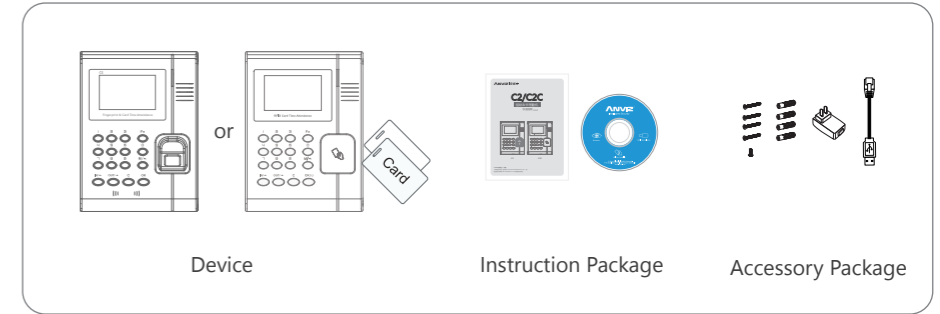

Device

Instruction Package

Accessory Package

3. Installation Diagram

Diagram

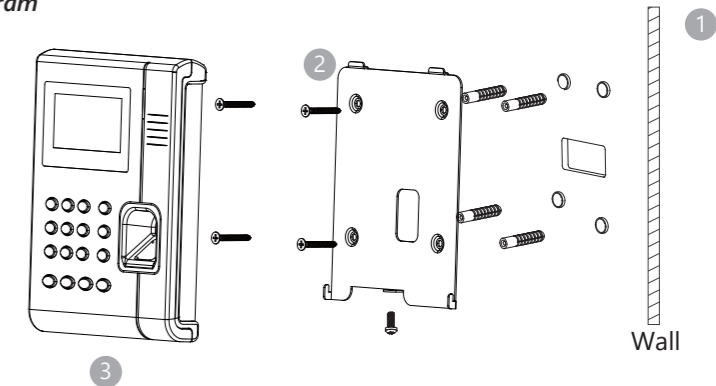

Installation Steps

1. Drill holes in the wall following the hole position on back panel
2. Install and fix back panel on the wall, connect power
3. Slide the C2/C2C onto the panel and secure with the screw on the bottom

4. Basic Operation

• Basic Setting



Plug in the power supply and wait for the device to boot up

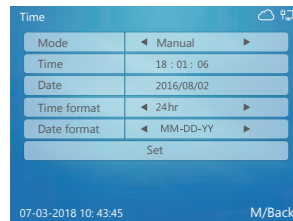

Go to Setting\Time menu to set up date and time

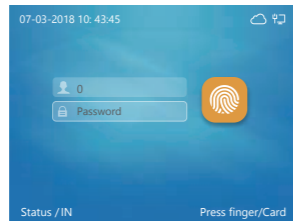

Press [M] key to go to Admin menu. Input "0" as ID and "12345" as password to log in

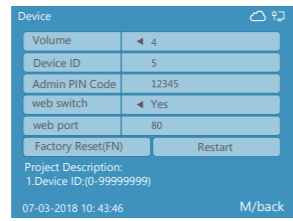

Browse the Setting\Device menu to view or edit the Device ID and Admin PIN Code

Reminder

0/12345 is the default Admin ID and password. You can change to your own password or set other user as Admin later.

• Add Users to Device



Go to User\Add menu. Follow the menu to input ID, name and password. Move the cursor to "Card" section

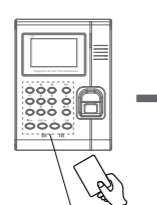

Swipe card in the card area, the device will get the card number. Move the cursor to "Enroll FP" section and click [OK] key



Scan the same finger three times to enroll the fingerprint

• Input Characters

When you edit name, you may need to input characters. Here are the steps to input characters:

- * Using the left and right arrow key to move the cursor to the field
- * Press [FN] key on the keypad, a character input window "Aa" will be displayed on the bottom of the screen. Then press the number/letter key.
- * A second window will appear and you can select the letter by number key
- * Press [IN] key on the keypad, the character input window will switch between "Aa", "123", "!,?" and "Pin". You can select the window to input the letter, number or special symbols.

• Verify the Fingerprint

Correct method:

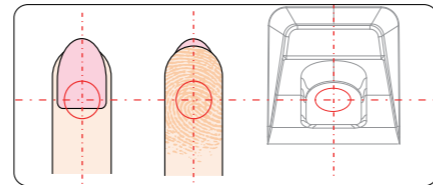

Place finger in the center of the sensor

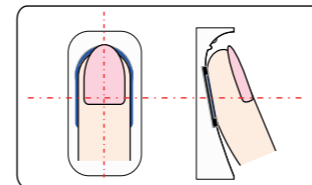

Place finger flatly and smoothly on the sensor

Incorrect method:

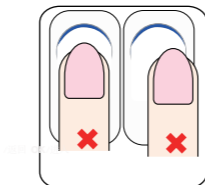

Finger not placed in the center of the sensor

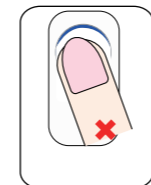

Finger placed askew

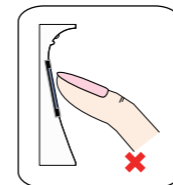

Use of fingertip

• Device Communication Setup

- * Go to Network\Internet menu to select Ethernet
- * Go to Network\Comm Mode to select Server or Client mode
- * Go to Network menu to setup Ethernet parameter according to your network settings
- * Ping the IP address of Device from the management computer. Make sure the Ping is successful

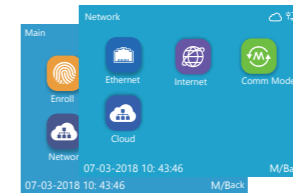

Go to Network menu

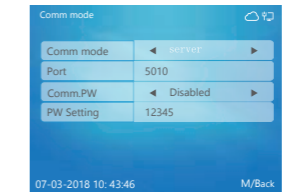

Go to Comm Mode menu to select Server or Client mode

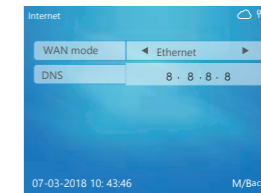

Go to Internet menu to set up WAN mode as "Ethernet" and input the DNS server IP address

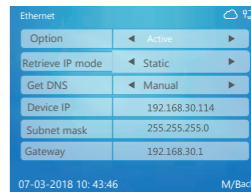

Go to Ethernet menu to change TCP/IP settings

5. Wiring Diagram

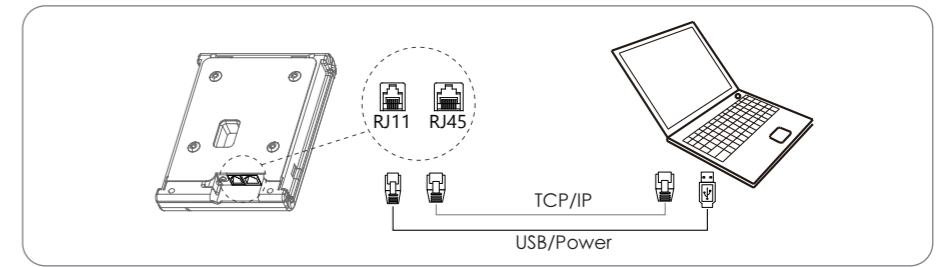

ANVIZ®

Anviz brand and product are trademarked and protected under law of the United States. Unauthorized use is prohibited. For more information, please visit www.anviz.com, or send email to sales@anviz.com for more help.

©2018 Anviz Global Inc. All Rights Reserved.